

CARSON®

MicroFlip™

100-250x LED UV Lighted Pocket Microscope

MP-250



Congratulations on selecting your new LED UV Lighted Pocket Microscope!
In order to achieve optimum performance, please follow instructions for proper use and care.

PRODUCT SPECIFICATION

Magnification:	100-250x	Battery:	1 AA
Weight:	0.18 lbs	Accessories:	Smartphone Clip, 1 Blank Slide with Coverslip and Wrist Strap
Dimensions:	1.5" x 1.0" x 5.5"		

MP-250 DIAGRAM

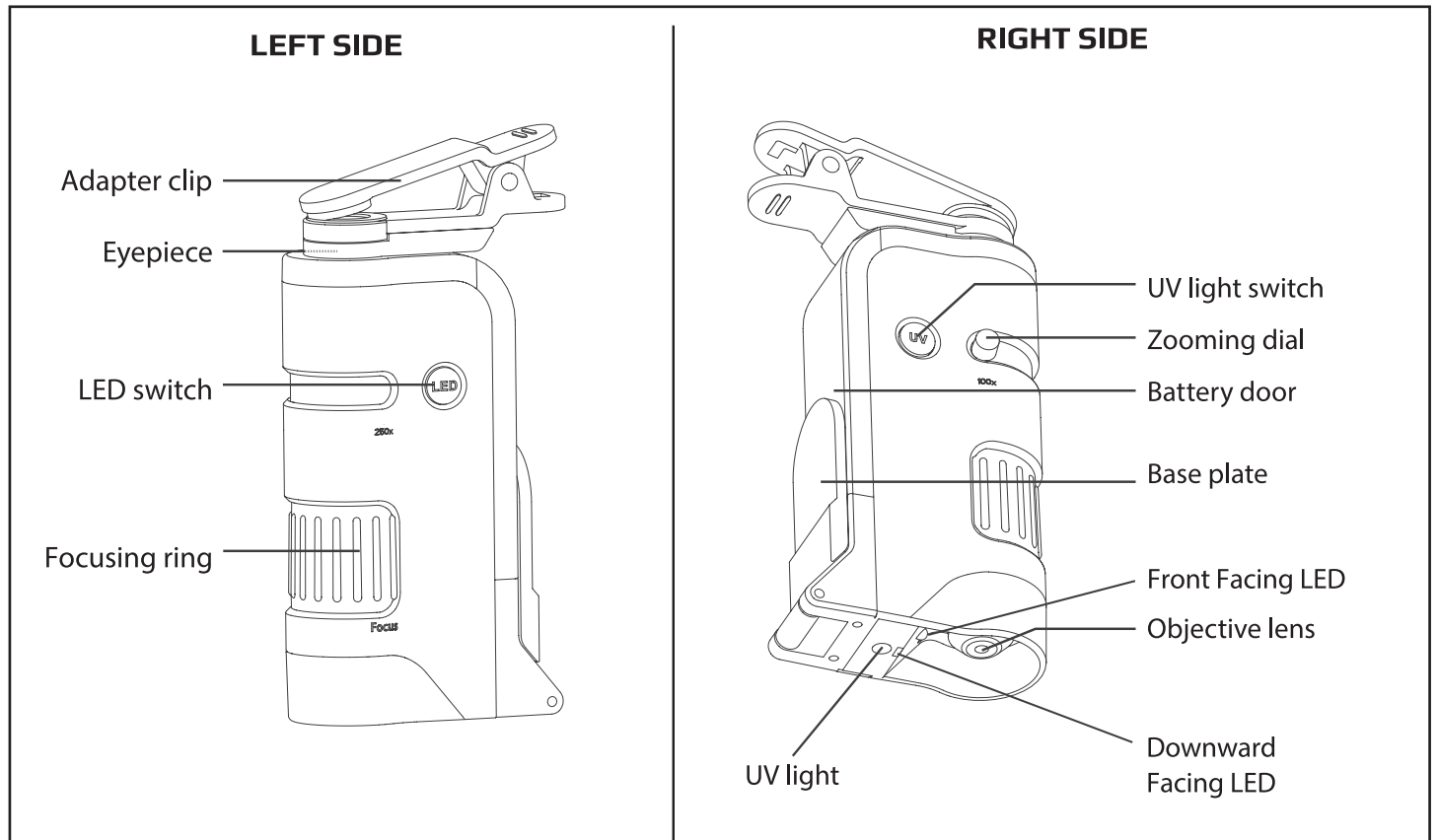

INSTALLING THE BATTERY

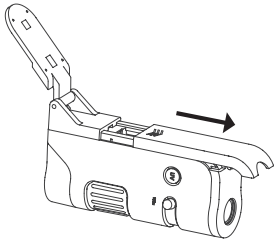

Slide battery door open.

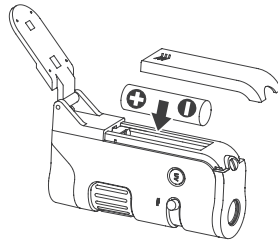

Insert 1 AA alkaline battery and replace battery door.

WARNING: Use only alkaline battery. Keep away from fire or excessive heat. Inspect battery for corrosion or leakage. Insert in direction indicated. Rechargeable battery not recommended.

USING MICROSCOPE TO VIEW OBJECTS DIRECTLY

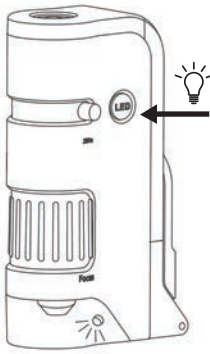

Press the LED switch for light.

WARNING: Do not look directly at LED light.

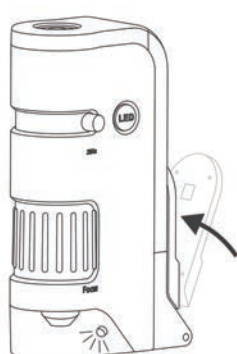

Base plate should be in upright position (behind battery door.)
Please note, when base plate is in upright position only front facing LED will illuminate.

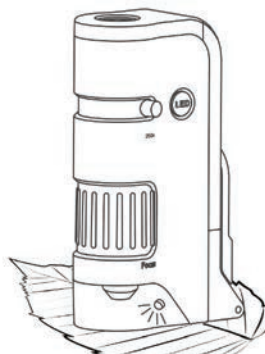

Place the viewing object directly below the objective lens.

ADJUSTING ZOOM & FOCUS

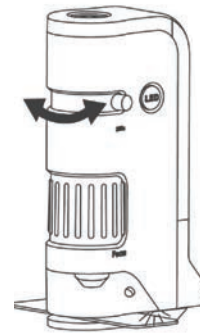

Adjust zooming dial for desired level of magnification.

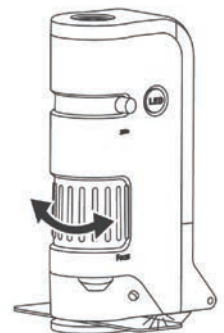

Rotate focusing ring until the image is clear and sharp.

USING MICROSCOPE TO VIEW SPECIMEN SLIDE

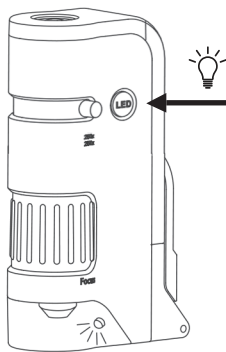

Press the LED switch for light.

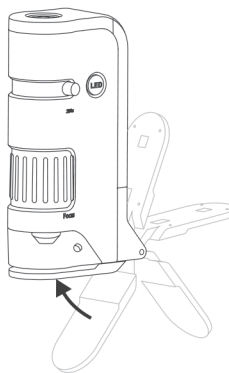

Flip base plate down to sit underneath the objective lens.
Please note, when base plate is down only downward facing LED will illuminate.

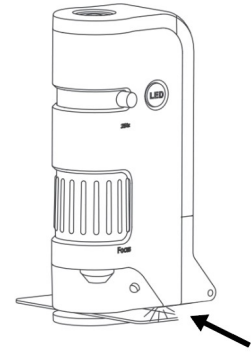

Insert a prepared slide into the slot between the objective lens and the base plate.

UV LIGHT:

Some subjects may have enhanced resolution when using the UV light.

Press and hold the UV light switch to activate the UV light.

Please note, the UV light is deactivated when the base plate is flipped down to the base of the microscope.

WARNING: Do not look directly at UV light.

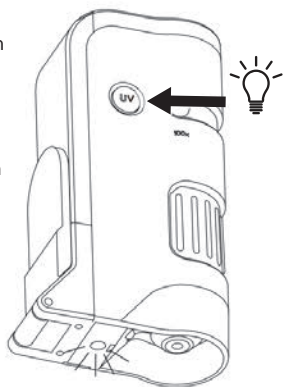

CARE

Clean using microfiber lens cloth. Do not use any abrasives, chemical cleaners, or solvents.

USING ADAPTER CLIP

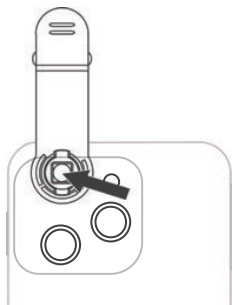

Align the camera of the phone to the center of the circular hole of the adapter clip.

MULTIPLE CAMERA PHONES:

If there is more than one rear facing camera, use the primary one. Typically, the primary is a 1x wide-angle color camera and the other camera(s) are secondary.

For the latest instructions on multiple camera phones, please visit www.carson.com/multicam

Attach the adapter clip to the top of the microscope and turn on camera.

If viewing image is not centered or is not a complete round image, adjust adapter clip making sure it is centered over camera.

Note: Always hold the phone securely during use. If you release the phone while it is attached to the microscope it can fall and damage the phone.

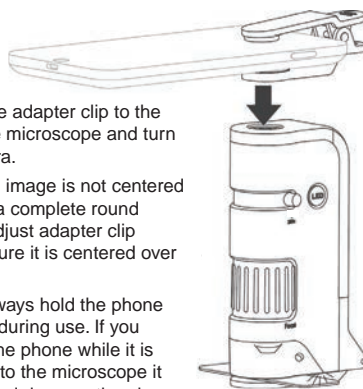

To maximize your image, pinch screen to enlarge. For best results, use in video mode.

Customer Service:

If you experience any difficulties, please contact us and we will be happy to help you.



✉ info@carson.com



✉ uksupport@carson.com



✉ eusupport@carson.com

For warranty information, visit www.carson.com/warranty

www.carson.com